

PATIENT MEDICATION INFORMATION

READ THIS FOR SAFE AND EFFECTIVE USE OF YOUR MEDICINE

Pr**OVIDREL**[®]

choriogonadotropin alfa

Read this carefully before you start taking **OVIDREL** and each time you get a refill. This leaflet is a summary and will not tell you everything about this drug. Talk to your healthcare professional about your medical condition and treatment and ask if there is any new information about **OVIDREL**.

What is OVIDREL used for?

OVIDREL is indicated for women following the stimulation phase of infertility treatment. OVIDREL is used to trigger ovulation in infertile women with ovarian dysfunction.

How does OVIDREL work?

OVIDREL is the only recombinant human chorionic gonadotrophin (r-hCG). Its generic name is choriogonadotropin alfa. hCG, is a hormone that is involved in reproduction in women. It is found in the urine of pregnant women and is produced by the placenta. OVIDREL is produced as a solution in a pre-filled syringe or a pre-filled pen that is intended for subcutaneous injection. OVIDREL ensures that you are receiving the highest purity hCG on the market. Subcutaneous injections offer the advantage of being convenient and easy to self-administer.

What are the ingredients in OVIDREL?

Medicinal ingredients: Pre-filled Syringe and Pre-filled - choriogonadotropin alfa

Non-medicinal ingredients:

Prefilled Syringe - L-methionine, Mannitol, Phosphoric acid, Poloxamer 188, Sodium hydroxide, Water for injection

Prefilled Pen: Disodium hydrogen phosphate dihydrate, L-methionine, Mannitol, Phosphoric acid, Poloxamer 188, Sodium dihydrogen phosphate monohydrate, Sodium hydroxide, Water for injection.

OVIDREL comes in the following dosage forms:

OVIDREL comes in two formats: 250 mcg in a pre-filled pen or 250 mcg in 0.5 ml for the ready to use solution packaged in a pre-filled syringe.

Do not use OVIDREL if:

- if you are allergic to choriogonadotropin alfa or any of the other ingredients of this medicine.
- if you have a tumour in your hypothalamus or pituitary gland (both are parts of the brain).
- if you have large ovaries or sacs of fluid within the ovaries (ovarian cysts) of unknown origin.
- if you have unexplained vaginal bleeding.
- if you have cancer of your ovaries, womb or breast.
- if you have severe inflammation of your veins or blood clotting in your veins (active thromboembolic disorders).
- if you have any condition that usually makes a normal pregnancy impossible, such as menopause or early menopause (ovarian failure), or malformations of sexual organs.

- if you have uncontrolled thyroid or adrenal dysfunction.
- if you have primary ovarian failure.

Other warnings you should know about:

- A higher risk of a blood clot

When undergoing assisted reproductive technologies or stimulation of your ovaries to produce eggs, there may be a higher occurrence of a miscarriage or pregnancy outside of the womb (ectopic pregnancy) than the average woman.

Reports of multiple births have been associated with fertility treatments. You should discuss the potential risk of multiple births with your doctor before beginning treatment.

To help avoid side effects and ensure proper use, talk to your healthcare professional before you take OVIDREL. Talk about any health conditions or problems you may have, including if you have:

- Severe pain
- Bloating in the stomach
- Bloating in the pelvic area
- Severe upset stomach
- Vomiting
- Weight gain

Contact your healthcare professional if you have any of these signs or symptoms. These are symptoms of a medical event called Ovarian Hyperstimulation Syndrome (OHSS). OHSS occurs infrequently (usually less than 3% incidence). However, because OHSS can progress rapidly to a serious medical event, OVIDREL should be stopped at the first signs of OHSS.

There is no evidence to establish an association between the administration of OVIDREL to female patients and the occurrence of congenital anomalies in their offspring. The data supporting this position is derived from the conclusions of clinical trials, as well as from post-marketing information where no cases of congenital anomalies have been reported since the introduction of OVIDREL to the market. Moreover, based on large epidemiological studies published in the literature, the rate of major or minor congenital anomalies following assisted reproductive technology procedures is consistent with that found in the unassisted population. It must be noted that these epidemiological studies relate to clinical trials carried out with urinary drugs. There is, however, no ground to suspect that, with regards to this particular risk, the recombinant product would be different from similar drugs of urinary origin.

Tell your healthcare professional about all the medicines you take, including any drugs, vitamins, minerals, natural supplements or alternative medicines.

The following may interact with OVIDREL:

Please inform your doctor and pharmacist if you are taking or have taken any other medications, even those not requiring a prescription.

How to take OVIDREL:

OVIDREL (choriogonadotropin alfa) offers the ease of use and convenience available with subcutaneous administration. Please familiarize yourself with the following instructions in order to understand how to self-administer OVIDREL.

Directions for Administration of OVIDREL in Pre-filled Syringe

OVIDREL in pre-filled syringes is intended for a single subcutaneous injection. Any unused material should be discarded. Ask your health care provider on how to dispose of used syringes and medicines no longer required. OVIDREL may be self-administered by the patient.

Follow the directions below for injecting OVIDREL

Step 1: Getting ready

On a clean work surface, lay out the items listed below before you begin:

- One OVIDREL pre-filled syringe
- Alcohol wipes (not supplied with the product)
- Sharps disposal container (not supplied with the product)

Step 2: Cleanse

- Wash your hands thoroughly with soap and water.
- It is important that your hands and the items you use be as clean as possible.
- Needles should not touch any surface except alcohol-cleaned skin; keep them capped prior to use.

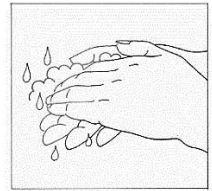

Step 3: Prepare Injection Site

- Select the site of injection (e.g. top of thigh, tummy). Refer to the injection site diagram.
- Wipe the chosen area with an alcohol wipe, cleansing an area of approximately 5 cm x 5 cm. Lay the used side of the wipe next to your working surface or on the alcohol wipe wrapper.
- Pick up the syringe and remove the cap from the needle.
- Invert the needle and hold as if “throwing a dart”. With your other hand, gently squeeze the skin together to make a little elevation at the injection site. Using a “dart like motion”, insert the needle at a 90 degree angle. (You need very little force but quick action.)
- Once the needle is inserted into the tissue all the way, inject the solution by pushing gently on the plunger with your thumb of the hand holding the syringe. Take as much time as you need to inject all the solution.
- Immediately withdraw the needle and clean the site with the clean side of the alcohol wipe using a circular motion. If there is minor oozing you may need to apply a small amount of pressure for a minute.

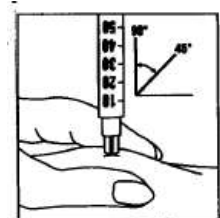
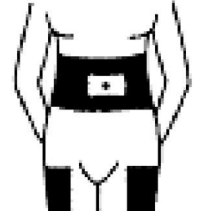

Step 4: Disposal of used Items

Once you have finished your injection, immediately discard the needles and syringe (without recapping the needle) into the disposal container. Take the container to a clinic or pharmacy for proper disposal.

Directions for Administration of OVIDREL in Pre-filled Pen

- This section tells you how to use your pen.

- Do not share the pen. The pen is for subcutaneous injection only.
- Inject OVIDREL as your doctor has taught you.
- **This pen is for single use only.**
- **Please read these directions for use before using your OVIDREL Pen. Follow the procedure exactly, as it may differ from your past experience.**

OVIDREL Pen, and other materials you may need for injection:

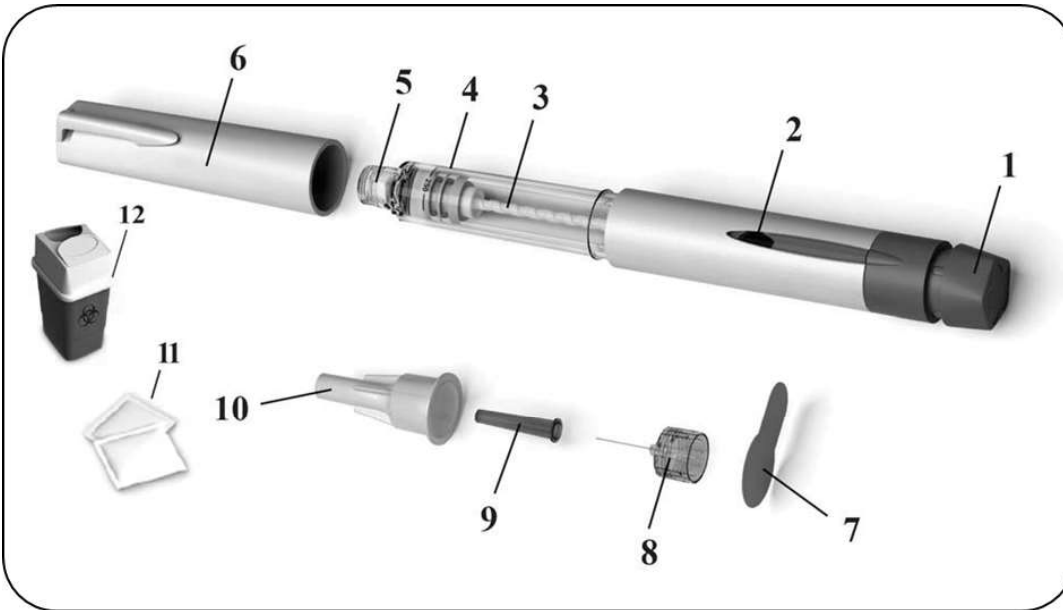

- | | | | |
|----|---------------------------|-----|---|
| 1. | Dose Setting Knob | 7. | Peel off seal tab |
| 2. | Dose Display | 8. | Removable needle |
| 3. | Plunger piston | 9. | Inner needle shield |
| 4. | Reservoir holder | 10. | Outer needle cap |
| 5. | Threaded needle connector | 11. | Alcohol wipes (not supplied with the product) |
| 6. | Pen cap | 12. | Sharps disposal container (not supplied with the product) |

Follow the directions below for injecting OVIDREL

1. Before you start using your OVIDREL Pen

- Wash your hands with soap and water. It is important that your hands and the items you use be as clean as possible.



- On a clean surface, e.g., clean table or kitchen surface, lay out everything you will need:
 - OVIDREL Pen
 - One removable injection needle
 - Alcohol wipes (not supplied with product)
 - Sharps disposal container (not supplied with product)
- Verify the **expiration date** on the pen label. Do not use expired medication.



2. Getting your OVIDREL Pen ready for injection

- Take off the pen cap.
- Wipe the end of the threaded tip (containing the rubber center) using an alcohol wipe.
- Look carefully at the reservoir holder. Check that the reservoir holder is not cracked and that the solution is clear and does not contain particles. If the reservoir holder is cracked or if the solution is discoloured or cloudy, obtain a new pen.
- Verify that the Dose Display is set to "0".

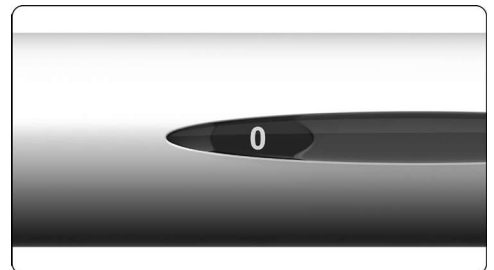
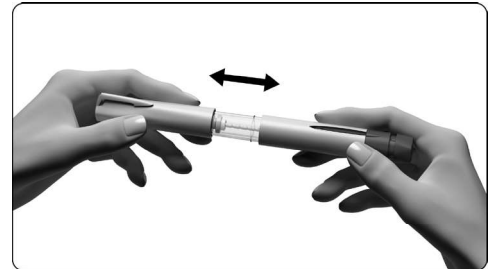

- Prepare your needle for injection:
 - Get a new needle – only use the 'single use' needles supplied for the OVIDREL Pen.
 - Hold the outer needle cap firmly.
 - Check that the peel-off seal on the outer needle cap is not damaged or loose. If it is damaged or loose, do not use the needle and get another. Throw away the unused needle with the outer needle cap still on, in a sharps container.

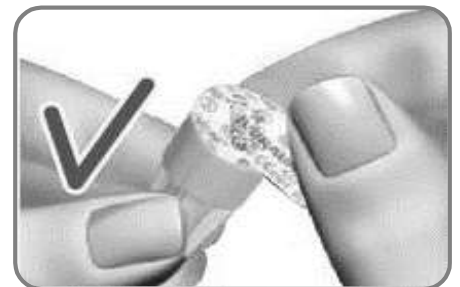

- Remove peel-off seal.



3. Attach the needle

- Press the threaded tip of the OVIDREL Pen into the outer needle cap and twist it clockwise until you feel a light resistance.
- Important Note: Do not attach the needle too tightly; the needle could be difficult to remove after the injection.



- Remove the outer needle cap by pulling it straight off.

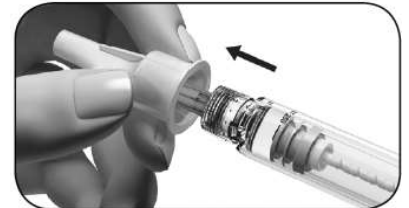

- Put it aside for later use.
- Do not throw away the outer needle cap; you will need it for removing the needle from the pen.

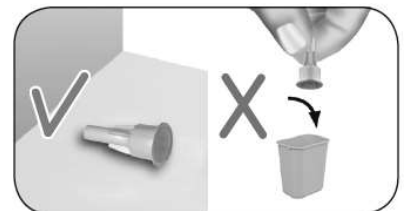

- Hold the OVIDREL Pen with the needle pointing upward.
- Carefully remove and discard the inner green shield.

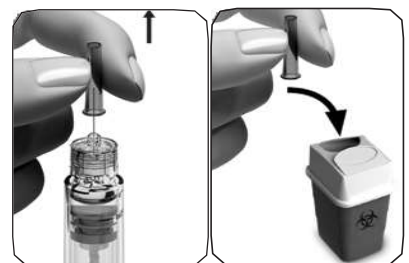

- Look closely at the tip of the needle for tiny drop(s) of fluid. If you see a tiny drop(s) of fluid, proceed to Section 4: **Setting the dose to 250.**

Caution: If you do not see a tiny drop(s) of fluid at or near the needle tip, you must perform the steps below:

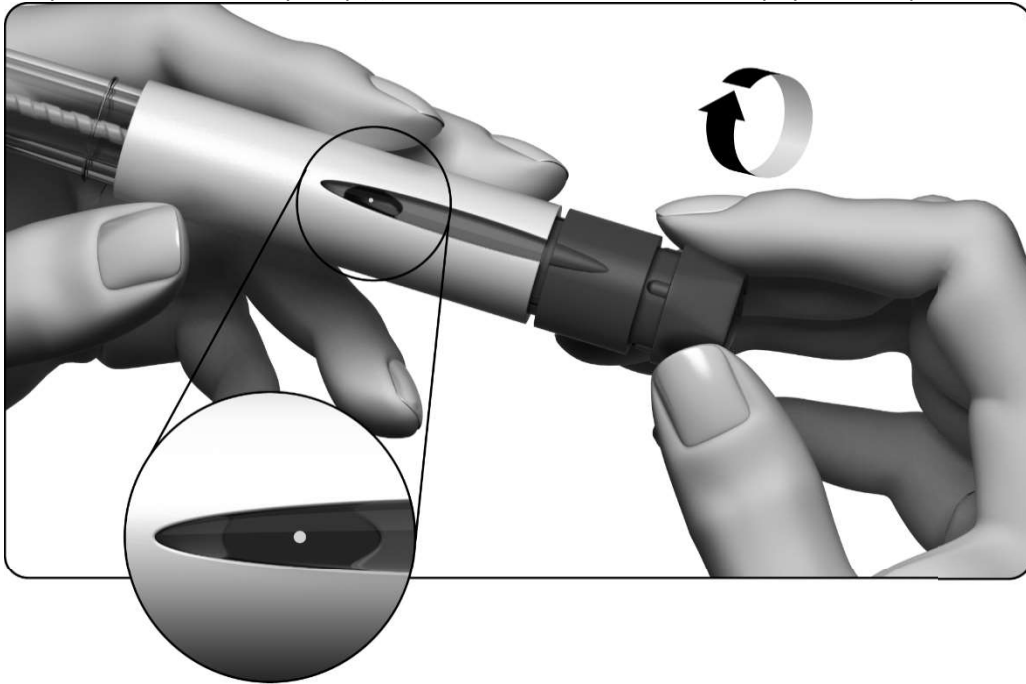

1. Gently turn the Dose Setting Knob clockwise until you see a dot (●) in the Dose Display. If you pass this position, simply turn the Dose Setting Knob back to the dot (●).
2. Hold the pen with the needle pointing upwards.
3. Tap the reservoir holder gently.
4. Press the Dose Setting Knob as far as it will go. A tiny drop of liquid will appear at the top of the needle; this shows that your prefilled pen is ready for injection.
5. If you do not see any liquid, you may try a second time (you may do this a maximum of two times) starting from Step 1 of this section “If you do not see a tiny drop of fluid at or near the needle tip” above.

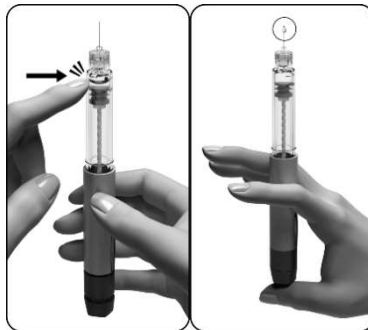

4. Setting the dose to 250

- Gently turn the Dose Setting Knob clockwise. The Dose Display will show a straight line and you have to keep turning until you can read the number “250”.
- Do not push or pull the dose setting button while you turn it.

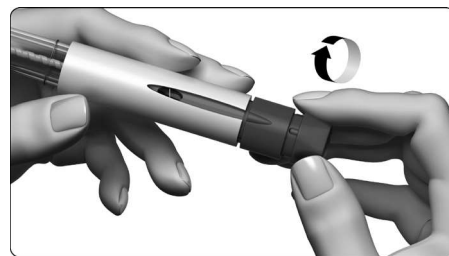

- If not already done while removing air, carefully remove the inner needle shield.
- Check that the Dose Display shows “250” before you move on to the next step.

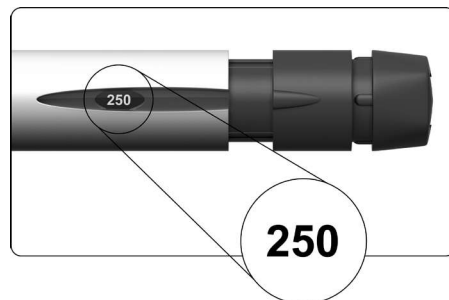

5. Injecting your dose

- Choose the place to give the injection where your doctor or nurse has told you – usually on your upper thighs or abdomen.

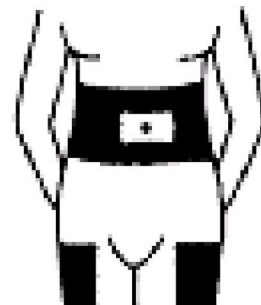

- Clean the skin by wiping the area with an alcohol wipe. Allow the site to dry.
- Lay the used side of the alcohol wipe to the side.
- Verify once more that the Dose Display reads “250”. If it does not, you must adjust it (see step 4. **Setting your dose to 250**).
- Inject the dose as you were told to by your doctor or nurse.
- Holding the pen in one hand, use your other hand to gently squeeze the skin together to make a raised area at the injection site. Slowly push the needle into the skin (1).
- Insert the needle at a 90° angle into the skin. You might bend the needle if you do not insert it at a 90° angle.
- Press the Dose Setting Knob down as far as it will go and hold it to complete the full injection.



- Hold the Dose Setting Knob down for a minimum of 5 seconds to ensure you inject the full dose (2). **Do not release the Dose Setting Knob until you remove the needle from your skin.**
- Remove the needle from your skin (3), release the Dose Setting Knob.
- The dose number shown in the Dose Display will turn back to “0”. This shows that the complete dose was delivered.
- Use the clean side of the alcohol wipe to gently apply pressure where you have just injected.

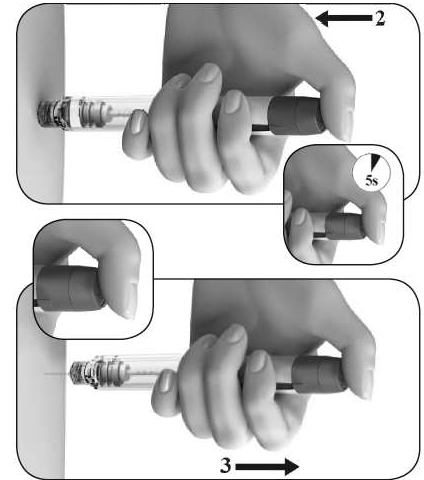

6. After the injection

- Verify you have given a complete injection.
- Check that the Dose Display reads “0”.
- This confirms that your dose has been fully delivered. **Do not attempt to inject a second time.**
- **In case the Dose Display doesn’t show “0”, please contact your doctor.**

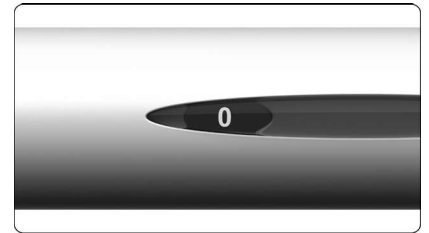

7. Removing the needle after injection

- Hold the pen firmly by the reservoir holder.
- Carefully put the outer needle cap back onto the needle. Be careful not to prick yourself with the needle.
- Grip the outer needle cap and unscrew the needle by turning the cap counter clockwise. Dispose of the used needle safely.

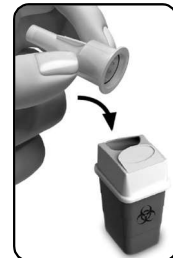
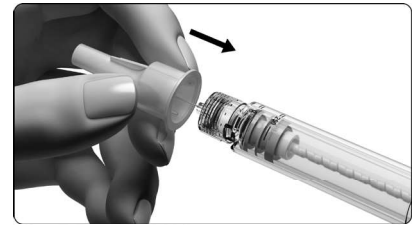

8. Disposal

- Use the needle and pen only once.
- Discard the pen.
- When the pen is empty, ask your pharmacist how to dispose of it.
Important note: Medicines should not be disposed of via wastewater or household waste.

Storing the pre-filled syringe and pre-filled pen

- Refer to the date indicated on the labels for expiry date. Do not use after expiry date.
- Do not freeze. Protect from light. Store in original package.
- Do not use the OVIDREL pre-filled syringe or pre-filled pen if the solution contains particles or is not clear.
- OVIDREL in pre-filled pens are to be stored at 2-8°C (in a refrigerator).
- OVIDREL in pre-filled syringes are to be stored at 2-8°C (in a refrigerator). The patient may store the pre-filled syringe at 25°C (room temperature) for up to 30 days, however after this time the pre-filled syringe should be discarded.

If you have any further questions on the use of this medicine, ask your doctor or pharmacist.

Usual dose:

OVIDREL should not be administered until adequate follicular development is indicated by serum estradiol and/or vaginal ultrasonography

OVIDREL 250 mcg should be administered subcutaneously one day following the last dose of the follicle stimulating agent. OVIDREL administration should be withheld in situations where there is an excessive ovarian response, as evidenced by multiple follicular development, clinically significant ovarian enlargement or excessive estradiol production.

Overdose:

No case of overdosage has been reported. Nevertheless, there is a possibility that OHSS may result from an overdosage of OVIDREL.

If you think you, or a person you are caring for, have taken too much OVIDREL, contact a healthcare professional, hospital emergency department, or regional poison control centre immediately, even if there are no symptoms.

What are possible side effects from using OVIDREL?

These are not all the possible side effects you may have when taking OVIDREL. If you experience any side effects not listed here, tell your healthcare professional.

The following side effects have been reported with the use of OVIDREL:

- Discomfort at the injection site
- Stomach pain
- Nausea
- Vomiting

Ask your fertility team to discuss the possible side effects with you. As with all medications, it is important to report any physical changes and all symptoms to your healthcare professional.

If you have a troublesome symptom or side effect that is not listed here or becomes bad enough to interfere with your daily activities, tell your healthcare professional.

Reporting Side Effects

You can report any suspected side effects associated with the use of health products to Health Canada by:

- Visiting the Web page on Adverse Reaction Reporting (<https://www.canada.ca/en/health-canada/services/drugs-health-products/medeffect-canada.html>) for information on how to report online, by mail or by fax; or
- Calling toll-free at 1-866-234-2345.

NOTE: Contact your health professional if you need information about how to manage your side effects. The Canada Vigilance Program does not provide medical advice.

Storage:

- Refer to the date indicated on the labels for the expiry date. Do not use after expiry date.
- Do not freeze. Store in the original package. Protect from light.
- OVIDREL in pre-filled syringes are to be stored at 2-8°C (in a refrigerator). The patient may store the pre-filled syringe at 25°C (room temperature) for up to 30 days, however after this time the pre-filled syringe should be discarded.
- OVIDREL in pre-filled pens are to be stored at 2-8°C (in a refrigerator).
- Keep out of reach and sight of children.

If you want more information about OVIDREL:

- Talk to your healthcare professional
- Find the full product monograph that is prepared for healthcare professionals and includes this Patient Medication Information by visiting the Health Canada website: (<https://www.canada.ca/en/health-canada/services/drugs-health-products/drug-products/drug-product-database.html>); the manufacturer's website <https://medinfo.emdserono.ca/en>, or by calling 1-800-677-3243.

OVIDREL® is a trademark of Merck KGaA, Darmstadt, Germany or its affiliates.

This leaflet was prepared by EMD Serono, a Division of EMD Inc., Canada.

Last Revised March 25, 2022